

# JVC

## SERVICE MANUAL

### CAR STEREO SPEAKER

## CS-VP6938

Service maintenance does not apply to this product.

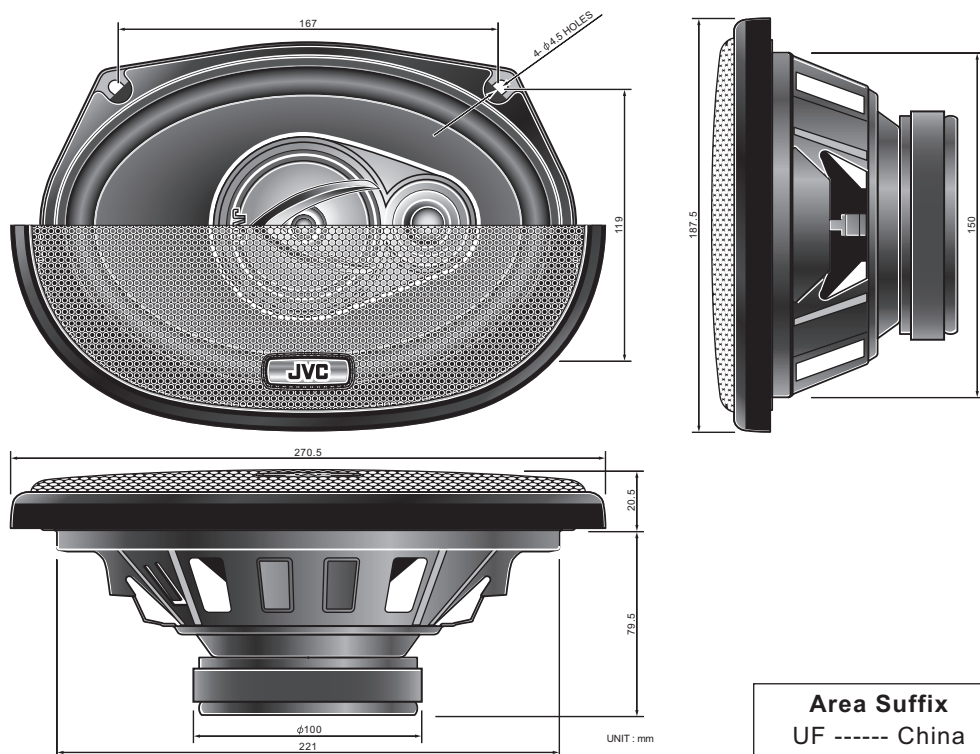

### SPECIFICATION

Type	15 cm × 23 cm (6" × 9") 3-Way Coaxial Speaker,Rear mounting
Power Handling Capacity	240 watts (MAX. MUSIC POWER)
Impedance	4 Ω
Magnet Mass	474 g (16.7 oz)
Mass	1.79 kg (4 lbs)

Design and specifications are subject to change without notice.

# SECTION 1 PRECAUTION

## 1.1 Safety Precautions

 **CAUTION** Burrs formed during molding may be left over on some parts of the chassis. Therefore, pay attention to such burrs in the case of performing repair of this system.

# SECTION 2 SPECIFIC SERVICE INSTRUCTIONS

## 2.1 ACCESSORIES

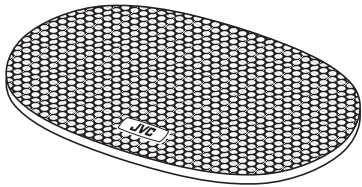

Metal Net ----- x 2

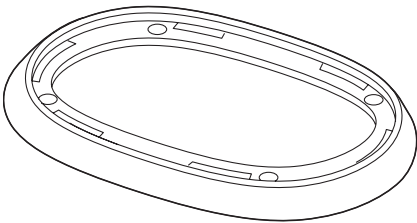

Grille ----- x 2

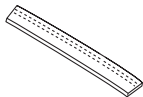

Net Fixer (10 cm) -----x 2

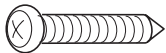

Screw (M4 x 70 mm) ----- x 8

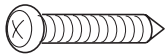

Screw ( $\phi$ 4 x 25 mm) ----- x 8



Nut (M4) ----- x 8



Speed Nut ----- x 8



Speaker Cord (5 m) ----- x 2



Plane Washer (M4) ----- x 8



Spring Washer (M4) ----- x 8

**SECTION 3  
DISASSEMBLY**

This service manual does not describe DISASSEMBLY.

**SECTION 4  
ADJUSTMENT**

This service manual does not describe ADJUSTMENT.

**SECTION 5  
TROUBLE SHOOTING**

This service manual does not describe TROUBLE SHOOTING.



**JVC**

VICTOR COMPANY OF JAPAN, LIMITED

AV & MULTIMEDIA COMPANY MOBILE ENTERTAINMENT CATEGORY 10-1,1chome,Ohwatari-machi,Maebashi-city,371-8543,Japan

(No.MA024)



Printed in Japan  
WPC